

Low pressure series

Micro annular gear pump mzr®-4622

Dosing pump for analytical instrumentation



- **Compact dimensions**
diameter 16 mm, length 88 mm
- **Small dosage volumes, high flow rates**
smallest volume 2 µl – flow up to 72 ml/min
- **High dosage precision**
precision CV 1 % at low volumes
- **Long service life**
wear-resistant tungsten carbide
- **Low pulsation delivery, low shear stress**
rotary micro annular gear technology

The compact micro annular gear pump mzr-4622 of the low pressure series is an innovative pump concept for use in analytical instrumentation. The pump generates a low pulsation, highly

precise flow featuring low shear stress. It dispenses at a high precision the lowest volumes in microliter range. Due to its compact design small dimensions have been achieved.

The pump is suitable for dosage of low viscosity liquids such as deionized water, watery solutions, methanol, solvents, oil and lubricants.

Applications

- Analytical instrumentation
- Fuel cells
- Laboratory automation
- In vitro diagnostics

Technical data

Flow rate	1.2 – 72 ml/min (min. 0.012 ml/min *)
Smallest dosage volume	2 µl
Displacement volume	12 µl
Differential pressure range	0 – 5 bar (73 psi)
Max. inlet pressure	1 bar (15 psi)
Pulsation	6 %
Operating temperature range	-20 ... +60 °C
Viscosity range	0.3 ... 100 mPas (max. 1000 mPas *)
Precision	1 % Coefficient of Variation CV
Speed range	100 – 6000 rpm (min. 1 rpm *)
Fluid connection	slip fittings with outside diameter 2 mm optional: manifold assembly
Wetted parts	stainless steel 316L, ceramics, tungsten carbide Ni-based, epoxy resin shaft seal: graphite-reinforced PTFE, stainless steel 316L static seals: FPM, optional: EPDM, FFPM
Motor	DC-motor with graphite brushes, assigned power rating 4.5 W, nominal voltage 24 V, digital magnet encoder 32 counts per turn
Electrical connection	10-pole connector
Dimensions	diameter 16 mm, length 88 mm
Weight	approx. 100 g

Customized solutions on request. * with optional high resolution encoder, gear box

Contact

HNP Mikrosysteme GmbH
Bleicherufer 25 · D-19053 Schwerin

phone +49 385 52190-301
fax +49 385 52190-333

e-mail info@hnp-mikrosysteme.de
<http://www.hnp-mikrosysteme.de>

Dimensions

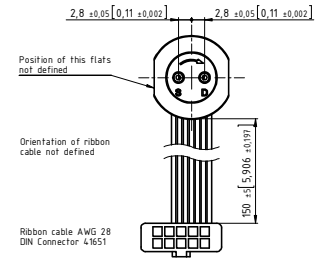
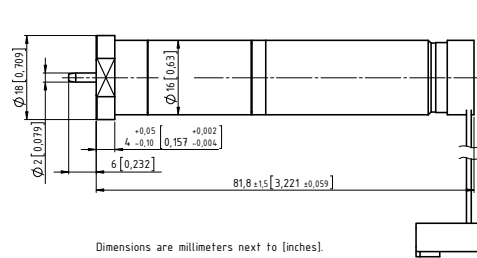
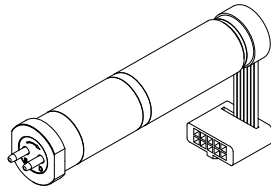

Configuration with slip fittings OD 2 mm

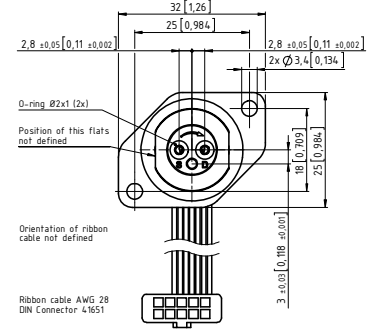
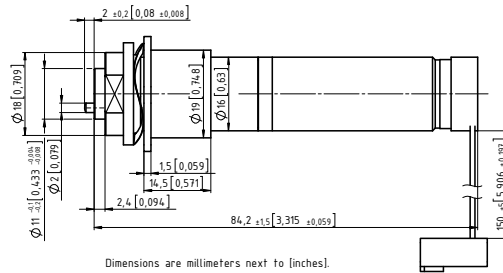
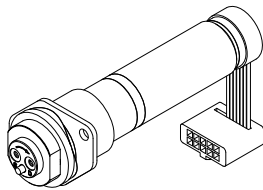

Configuration with a manifold assembly M2.1

Subject to technical changes.

Flow charts

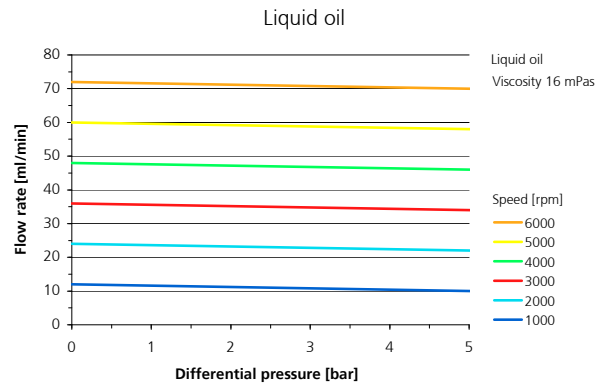
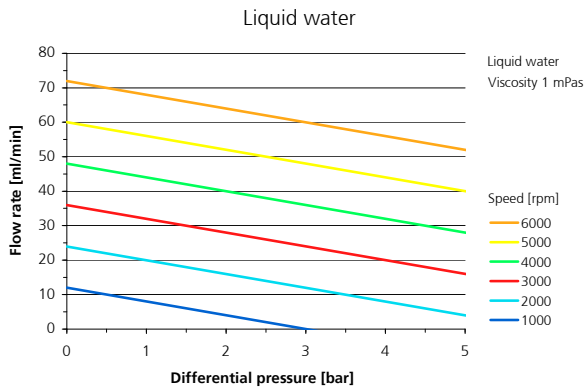

Item number

11 04 01 03	low pressure series pump mZR-4622, with DC-motor, encoder 32 counts per turn, fluid connection slip fittings OD 2 mm
11 04 02 04	low pressure series pump mZR-4622 M2.1, with DC-motor, encoder 32 counts per turn, fluid connection manifold assembly

Accessories

Liquid supply accessories	tubes, filters etc.
Control	S-KD-22: control for continuous delivery S-ND: programmable microcontroller-based control for continuous delivery and discrete dosage
Console drive module	diecast aluminum chassis mZR-S06 for laboratory and testing
Multiplexer module	simultaneous operation of up to 255 pumps with a single RS-232 interface

Even if single parameters are within their indicated performance range, certain parameter combinations may not be achievable. Single parameters may exceed their indicated performance range under adequate circumstances. For detailed evaluation please contact HNP Mikrosysteme. Actual performance may vary. Specifications are subject to change without notice.

Micro annular gear pumps (and housings) are protected by assigned patents: DE 198 43 161 C2, EP 1115979 B1, US 6,520,757 B1, EP 852674 B1, US 6,179,596 B1, EP 1354135, US 7,698,818 B2. Patents pending: EP 1807546, DE 10 2009 020 942.5-24, DE 10 2011 001 041.6. In the US, Europe and China additional patents are pending. mZr®, MoDoS®, µ-Clamp® are registered German trademarks of HNP Mikrosysteme GmbH. Kalrez® Spectrum™ is a registered trademark of DuPont.